

Data Sheet

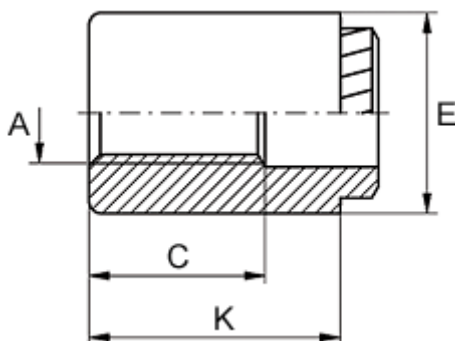

Article number: 12513600030100
Description: KLEE-coil 513 600 030.100
M3 Hardened, zinc-pl.

Measures



Female thread A	= M3
Height K	= 13
Hole diameter +0.1	= 4.2
Min distance to edge	= 2.4
Min material thickness	= 1.5
Outer diameter E	= 7
Thread length	= 9